

# M7260

## SPECIFICATION

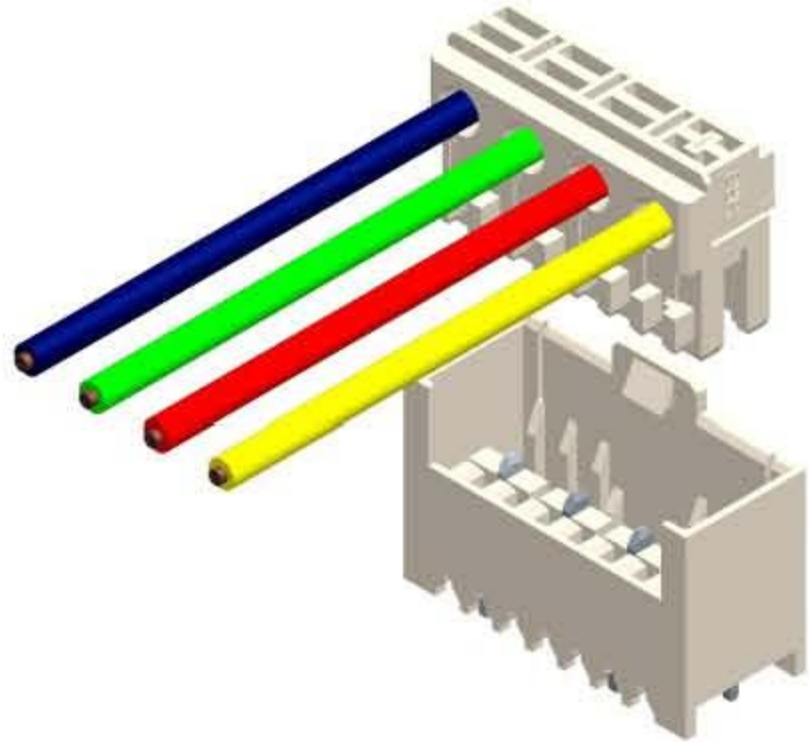

Current rating: 6AAC, DC  
 Voltage rating: 250V AC, DC  
 Operating Temperature: -40°C--+120°C  
 Contact Resistance: 10mΩ max.  
 Insulation resistance: 1000MΩ min.  
 Withstanding voltage: 2800V AC/minute  
 Material: Housing: Nylon66 UL94V-0  
 Terminal: Phosphor bronze, Tin-plated  
 Wire range: AWG 20 to 18  
 GWT:750°C IEC-60335-1

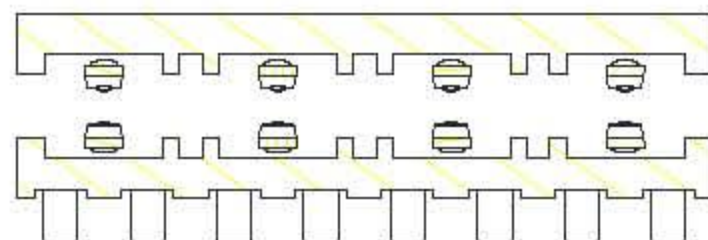
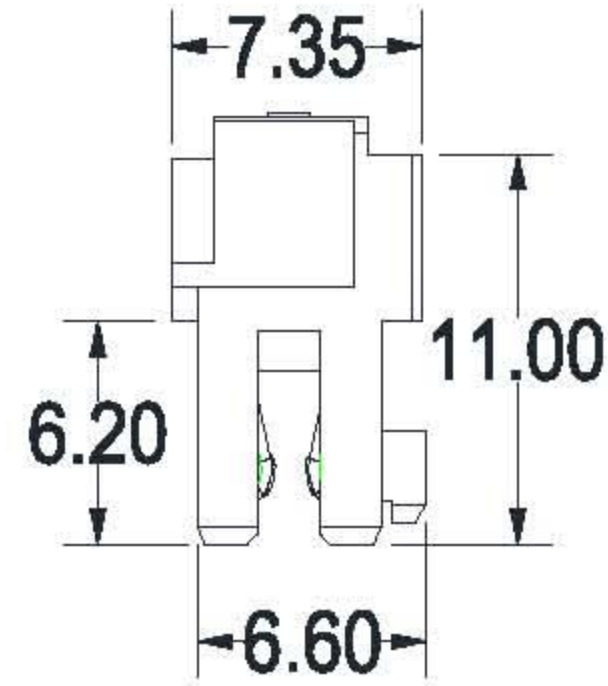
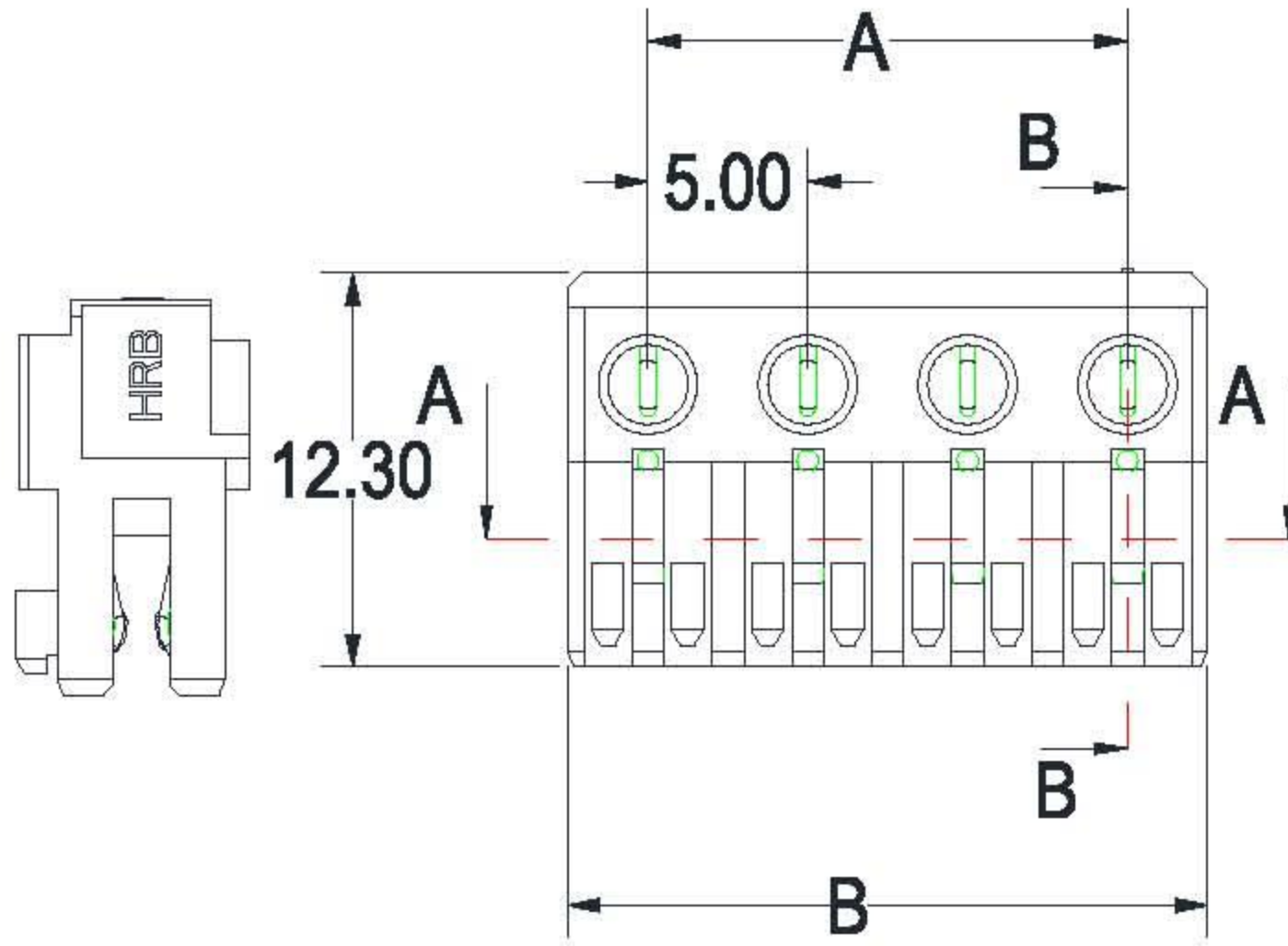

SECTION:A-A

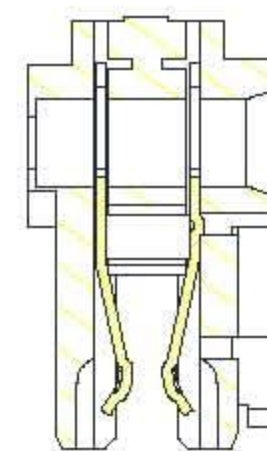

SECTION:B-B

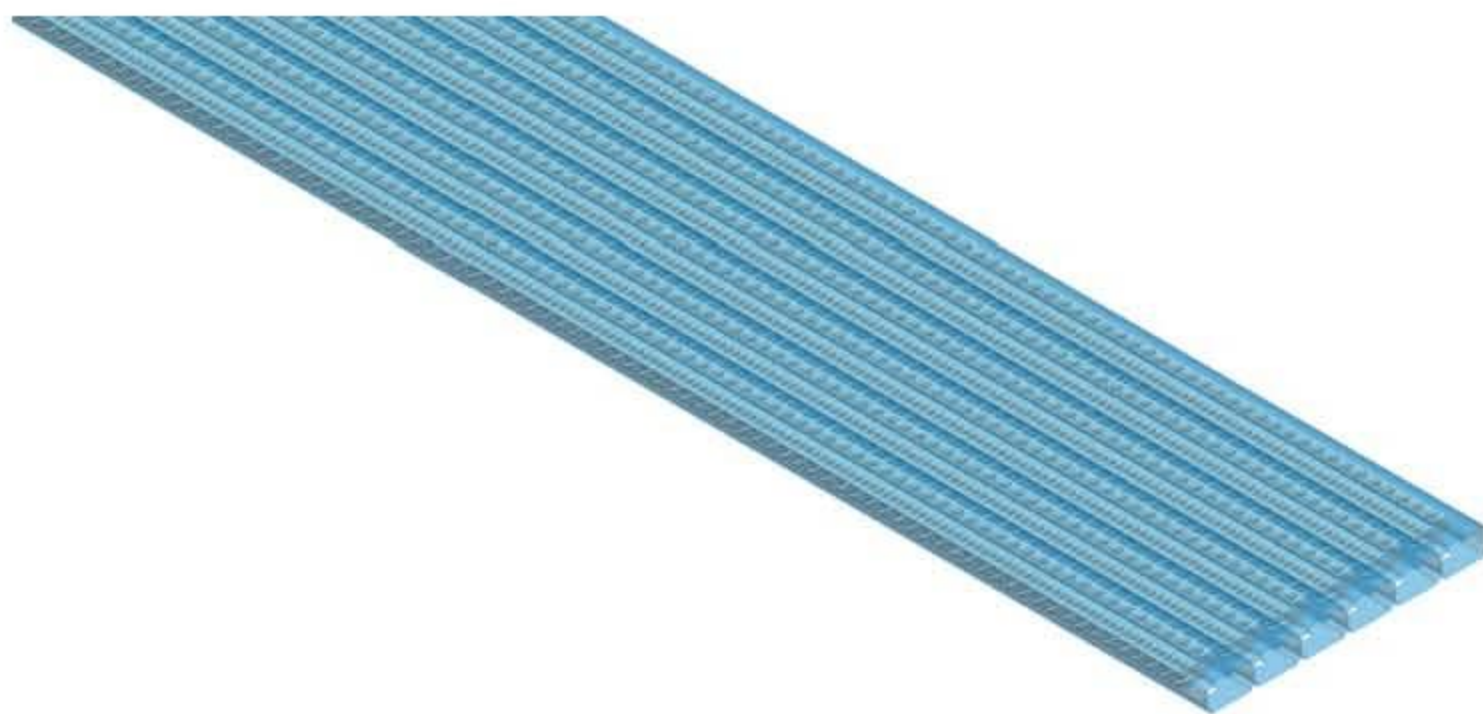

Pos.No.	Dimension	
	A	B
2	5	10
3	10	15
4	15	20
5	20	25
6	25	30
7	30	35
8	35	40
9	40	45
10	45	50



### M7260 Part Number Definition

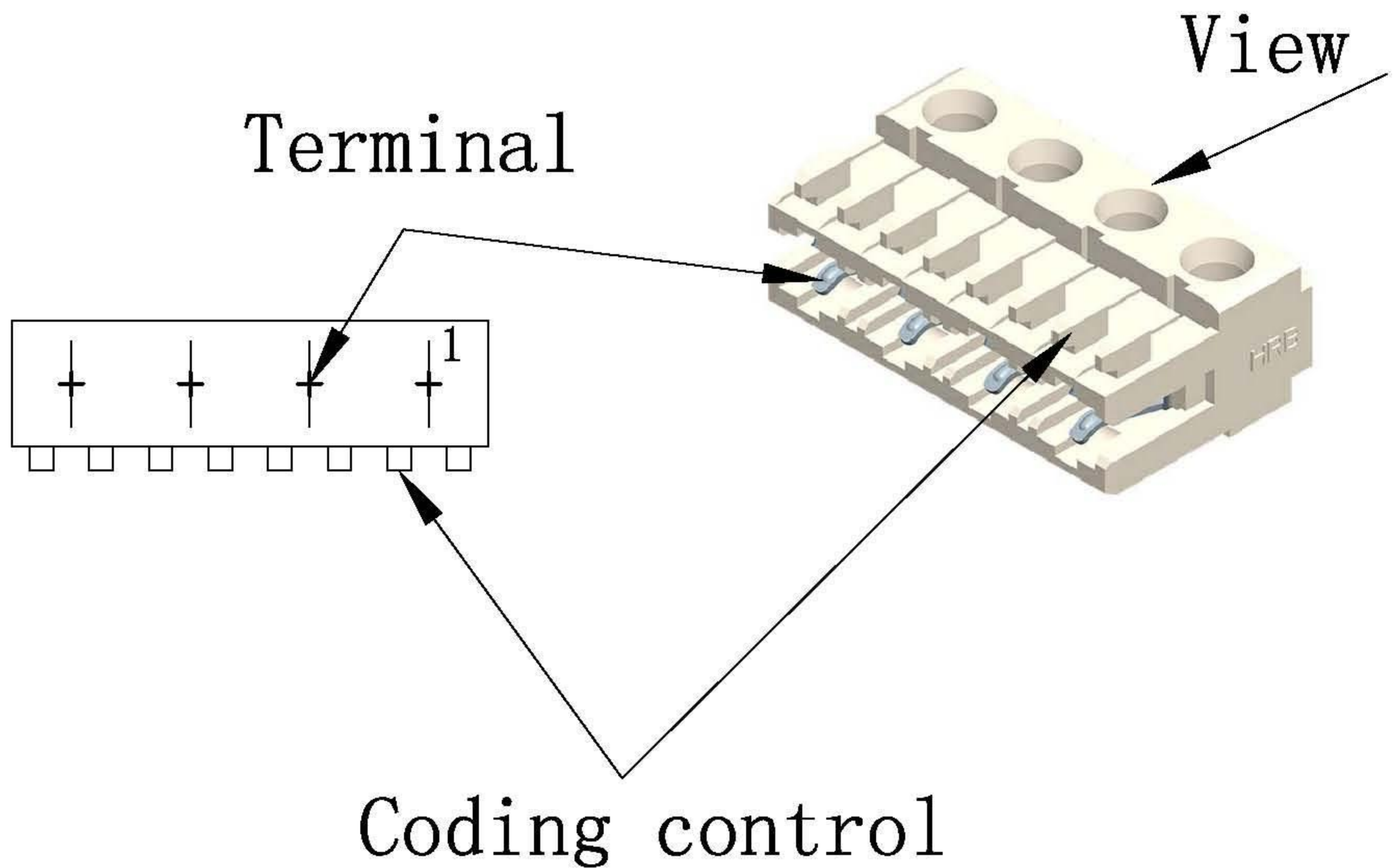
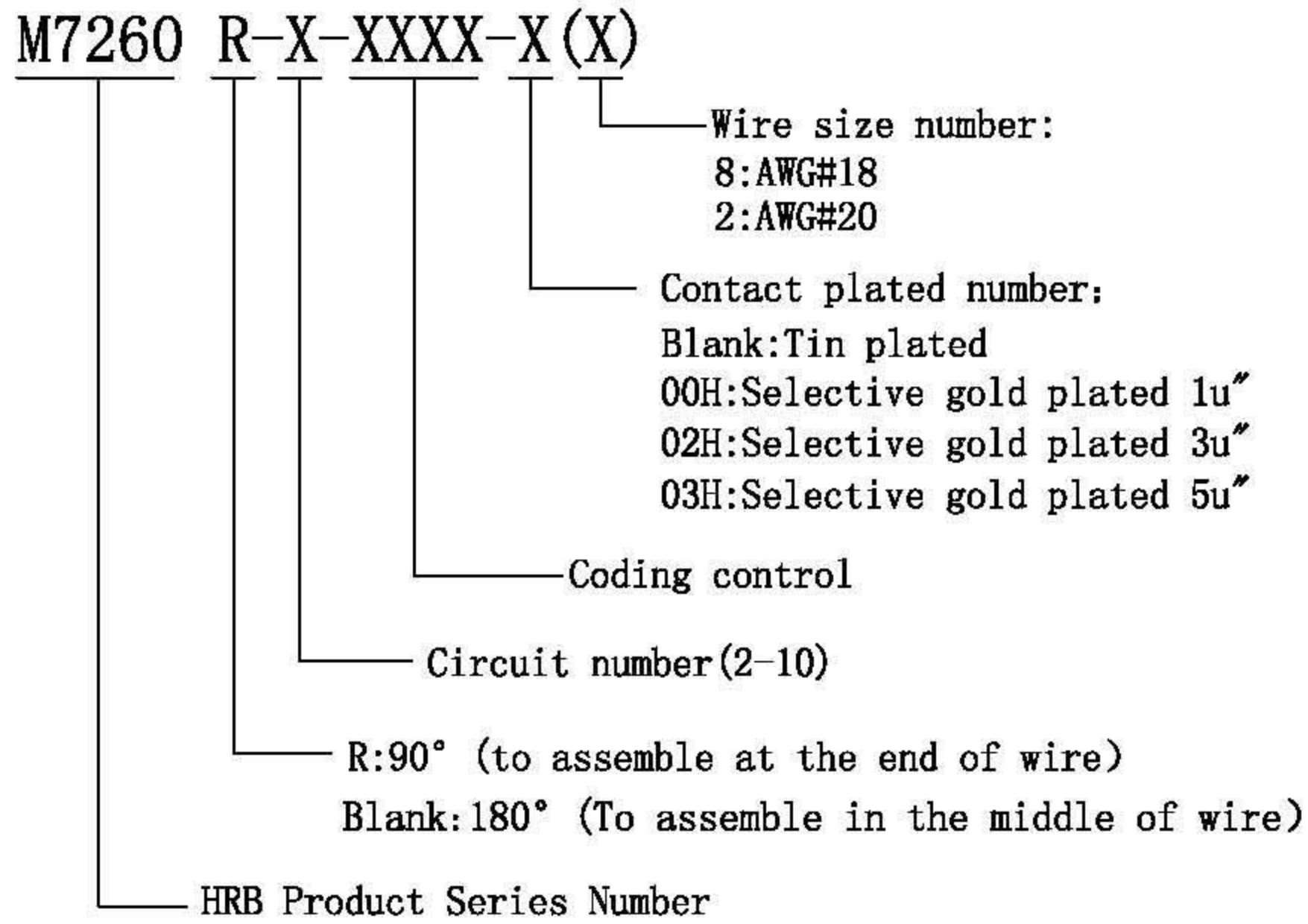

The following part numbers are the ones that have been producing in HRB. Of course, we can adjust the fool-proof positions and circuits of product to define some new part numbers and produce.

You're welcome to choose our product!

## 2 Circuits

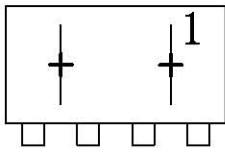

M7260R-2-0000 (2)

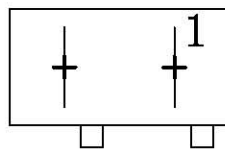

M7260R-2-0001 (8)

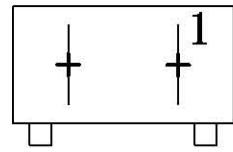

M7260R-2-0002 (2)

## 3 Circuits

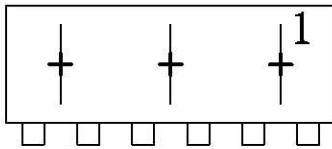

M7260R-2-0000 (2)